

22.89

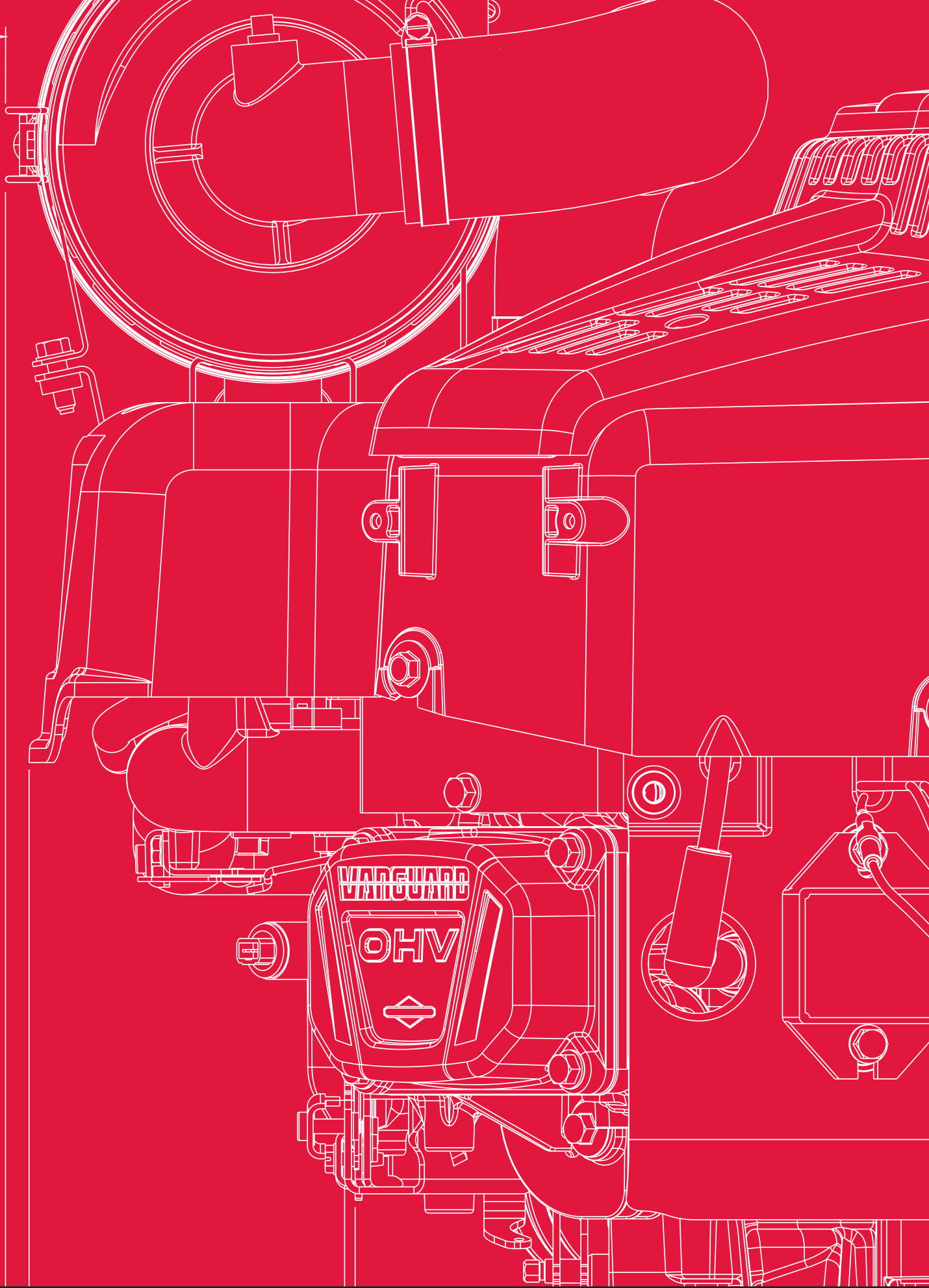

PRE-SEASON PROGRAMME
2015/16



ENGINECARE™



992230

450 SERIES™, 550 SERIES™, CLASSIC™, SPRINT™



992236

POWERBUILT™ OHV, INTEK™ I/C® OHV, I/C® OHV
10.5HP – 13.5HP*



992231

450E SERIES™, 500E SERIES™



992238

MODEL 28, MODEL 31 I/C® OHV
14.5HP – 18.5HP* VERTICAL



992232

550E SERIES™, 575EX SERIES™,
550EX SERIES™ ECO-PLUS™



992240

VANGUARD™ V-TWIN MODEL 29, 30, 35 14HP – 20HP*



992233

625 SERIES™, 650 SERIES™, 675 SERIES™, QUANTUM®



992242

MODEL 21, SERIES 3 POWERBUILT™, INTEK™ I/C® OHV
21R5, 21R6, 21R7, 21R8



992234

700 SERIES™, 750 SERIES™, 750 SERIES™ I/C®, DOV®,
DOV® I/C®



992243

MODEL 31, SERIES 4 INTEK™
I/C® OHV 31R7, 31R8, 31R9



992235

800 SERIES™, 850 SERIES™, 850 SERIES™ I/C®,
875 SERIES™



STARTCARE 992210

FOR USE WITH ALL ENGINES WITH 0.6L OIL CAPACITY

* Power levels are stated gross horsepower per SAE J1940 as rated by Briggs & Stratton.

ENGINE OIL / FUEL FIT®



100004E

0,5 L



100005E

0,6 L



100009E

5 L



100007E

1 L



100046E

25 L



100006E

1,4 L



100047E

60 L



100008E

2 L



100048E

200 L



992380 / 992380FR

100ml



992381 / 992381FR

250ml



SPARK PLUG SELECTION

SMALL VERTICAL	PRODUCT RANGE	MODEL NUMBERS	SPARKPLUG REQUIRED
SERIES	450, 500, 550	09T5, 10T5, 10T6, 10T8	992300C (BS-SV-Cu)
E-SERIES	450E, 500E, 550E, 575EX, 550EX ECO PLUS™, 625E	08P5, 09P6, 09P7, 093J	692051*
SERIES / E-SERIES	625, 650, 675, 650 ECO PLUS™, 625E, 650E, 675EX, 650EX ECO PLUS™	122T, 124T, 126T, 124L	992300C (BS-SV-Cu)
EXI-SERIES / iS-SERIES	650EXi, 675EXi, 675iS INSTART®	103M, 104M	992304 (BS-OHV)
SERIES DOV® / E-SERIES DOV®	700, 700E	0906	992304 (BS-OHV)
SERIES DOV® / E-SERIES DOV® / iS-SERIES	750, 750EX, 750EX ECO PLUS™, 775iS INSTART®	1006	992304 (BS-OHV)
SERIES DOV® I/C® / E-SERIES DOV® I/C®	750EX	1008	992304 (BS-OHV)
SERIES / E-SERIES	800, 800E	11P9, 112P	992304 (BS-OHV)
SERIES	850, 875, 850 ECO PLUS™	12R9, 12S9, 122S, 122R	992304 (BS-OHV)
E-SERIES / iS-SERIES	850E, 875EX, 850EX ECO PLUS™, 875iS INSTART®	12R9, 12S9, 122S, 122R, 111P	992304 (BS-OHV)
SERIES I/C® / E-SERIES I/C®	850	12Q9, 122Q	992304 (BS-OHV)
E-SERIES	950	14B9	992304 (BS-OHV)

LARGE VERTICAL	PRODUCT RANGE	MODEL NUMBERS	SPARKPLUG REQUIRED
POWER BUILT™ OHV	10.5, 11.5, 12.5, 13.5	2158, 2178, 2198, 21B8	992304 (BS-OHV)
POWER BUILT™ OHV	14.5, 15.5, 16.5	31A5, 31A6, 31A7	992304 (BS-OHV), 992306 (BS-OHV-HT)
POWER BUILT™ OHV	17.5, 18.5	31C7, 31N7	992304 (BS-OHV), 992306 (BS-OHV-HT)
INTEK™ OHV	13.5	21B9	992304 (BS-OHV)
INTEK™ OHV	17.5, 18.5, 19.5	31G7, 31P7, 31P6	992304 (BS-OHV), 992306 (BS-OHV-HT)
INTEK™ OHV	21.0	3318	992304 (BS-OHV), 992306 (BS-OHV-HT)
INTEK™ V-TWIN OHV	16.0, 18.0, 20.0, 22.0	4015, 4055, 4067, 4077	992304 (BS-OHV), 992306 (BS-OHV-HT)
INTEK™ V-TWIN OHV	23.0, 24.0	4455, 4456	992304 (BS-OHV), 992306 (BS-OHV-HT)
PROFESSIONAL SERIES™ OHV	21.0	33M7	992304 (BS-OHV), 992306 (BS-OHV-HT)
PROFESSIONAL SERIES™ V-TWIN OHV	20.0, 22.0	40G7, 40H7	992304 (BS-OHV), 992306 (BS-OHV-HT)
PROFESSIONAL SERIES™ V-TWIN OHV	23.0, 24.0	44L7, 44M7	992304 (BS-OHV), 992306 (BS-OHV-HT)
VANGUARD™ V-TWIN OHV	14.0, 16.0	2957, 3057	992304 (BS-OHV), 992306 (BS-OHV-HT)
VANGUARD™ V-TWIN OHV	18.0, 20.0	3567, 3587	992304 (BS-OHV), 992306 (BS-OHV-HT)
VANGUARD™ V-TWIN OHV	23.0	3867	992304 (BS-OHV), 992306 (BS-OHV-HT)

HORIZONTAL	PRODUCT RANGE	MODEL NUMBERS	SPARKPLUG REQUIRED
SERIES OHV	550	0831	797235*
SERIES OHV	750	1062	992304 (BS-OHV)
SERIES OHV	800, 900	1263, 1210	992304 (BS-OHV)
SERIES OHV	1450	2043	992304 (BS-OHV)
VANGUARD™ OHV	4.0	0864	992304 (BS-OHV)
VANGUARD™ OHV	5.5, 6.5	13H1, 13H3	992304 (BS-OHV)
VANGUARD™ OHV	7.5	1384	992304 (BS-OHV)
VANGUARD™ OHV	8.0, 10.0	19H1, 19H2	992304 (BS-OHV)
VANGUARD™ OHV	13.0	2454	992304 (BS-OHV)
VANGUARD™ V-TWIN OHV	14.0, 16.0	2954, 3054	992304 (BS-OHV), 992306 (BS-OHV-HT)
VANGUARD™ V-TWIN OHV	18.0	3564	992304 (BS-OHV), 992306 (BS-OHV-HT)
VANGUARD™ V-TWIN OHV	21.0, 23.0	3854, 3864	992304 (BS-OHV), 992306 (BS-OHV-HT)
VANGUARD™ BIG BLOCK™ V-TWIN OHV	25.0, 27.0, 29.0, 31.0	5404, 5414, 5424, 5434	992304 (BS-OHV), 992306 (BS-OHV-HT)
VANGUARD™ BIG BLOCK™ V-TWIN OHV	33.0, 35.0	6114, 6134	992304 (BS-OHV), 992306 (BS-OHV-HT)

* Not offered in Pre-Season Programme.

SPARK PLUGS



992300C

BS-SV-Cu



992301C

BS-SV-Cu



992359

BS-SV



992360

BS-SV



992306

BS-OHV-HT



992361

BS-OHV



992304

BS-OHV



992362

BS-OHV



992340

BS-OHV



BS-SV-Cu: BRIGGS & STRATTON SIDE VALVE (COPPER CORE)

BS-OHV: BRIGGS & STRATTON OVERHEAD VALVE

BS-OHV-HT: BRIGGS & STRATTON OVERHEAD VALVE HIGH TEMPERATURE

450 SERIES™ 500 SERIES™ 550 SERIES™

CLASSIC™, SPRINT™, QUATTRO™ – MODEL: 09x5, 09x9, 10x5, 10T6, 10x8, 10x9



450
SERIES™



500
SERIES™



550
SERIES™

	272235S			281505S	
	4107			4204	
	698369			499901	
	4216				
	694394			692299	
	4178				
	795083			790965	
				62m, Ø 3,2mm	
	497929S			493880S	
	4132				
	270344S			66538S	
	697316			222698S	
				4181	222698S
				4144	222698S
	281434S			992230	
				ENGINE CARE	
				450 SERIES™, 550 SERIES™, CLASSIC™, SPRINT™	

450E SERIES™ 500E SERIES™ 550E SERIES™ 575EX SERIES™

MODEL: 08P5, 09P6, 09P7



450E
SERIES™

500E
SERIES™

575EX
SERIES™



593260



4247

593260



270344S



799579



4248

799579



692076



591108



281434S



799585



799716



799580



222698S



4181

222698S

4144

222698S



799587



992231



ENGINE CARE
450E SERIES™, 500E SERIES™



692046



4221

692046



992232



ENGINE CARE
550E SERIES™, 575EX SERIES™,
550EX SERIES™ ECO-PLUS

625E SERIES™ 650E SERIES™ 675EX SERIES™

QUANTUM® – MODEL: 12xx



625E
SERIES™



650E
SERIES™



675EX
SERIES™

	491588S			791850	Ø 13mm
	4101			4171	791850
	491588L			4229	791850
	398188			698183	
	498260			692046	
	4180			4221	692046
	694395			270344S	
	4180			399781S	
	298090S			692232	
	4105			4182	692232
	395051R			693981	
7,5m – Ø int. 6,35mm, Ø ext. 11mm				795629	
	691038	Ø 11mm		4156	795629
	4230	691038			
	792020				
7,5m – Ø int. 6,35mm, Ø ext. 13mm					



280399S



799716



281434S



493880S



281505S



66538S



4204

281505S



498144



222698S



4181

222698S

4144

222698S



790965



62m, Ø 3,2mm



992233

ENGINE CARE

625 SERIES™, 650 SERIES™, 675 SERIES™, QUANTUM®



692299



625E SERIES™ OHV

MODEL: 093J



625E
SERIES™



593260

x1

4247

593260 x5



791850

Ø 13mm x1

4171

791850 x5

4229

791850 x100



591108

x1



692076

x1



799585

x1



281434S

x1



799580

x1



222698S

x1

4181

222698S x10

4144

222698S x50



799587

x1



692046

x1

4221

692046 x5

650EXi SERIES™ 675EXi SERIES™ 675iS SERIES™

MODEL: 103M, 104M



650EXi
SERIES™



675EXi
SERIES™



675iS
SERIES™



593260



4247

593260



692076



591108



281434S



799580



222698S



4181

222698S

4144

222698S



799587



791850

Ø 13mm

4171

791850

4229

791850

700E SERIES™ 750EX SERIES™ 775iS SERIES™

DOV® – MODEL: 0906, 1006, 1008, 1016









































700E
SERIES™



750EX
SERIES™



775iS
SERIES™

	792038 4245	 		692046 4221	 
	793676			399781S	
	298090S 4105	 		691894	
	395051R 7,5m – Ø int. 6,35mm, Ø ext. 11mm			280399S	
	691038 4230	Ø 11mm  		281434S	
	792020 7,5m – Ø int. 6,35mm, Ø ext. 13mm			790965 62m, Ø 3,2mm	
	791850 4171 4229	Ø 13mm   		799716	
	698183			493880S	



222698S

4181

4144



222698S **x10**

222698S **x50**



992234

ENGINE CARE

DOV®, DOV® I/C®, 700 SERIES™, 750 SERIES™, 750 SERIES™ I/C®



66538S



A QUANTUM LEAP

LIGHT

EASY

ADVANCED

POWER



800E SERIES™ 850E SERIES™ 875EX SERIES™ 875iS SERIES™

MODEL: 11P9, 12R9, 12S9, 12Q9, 121R, 111P



800E SERIES™ **850E** SERIES™

875EX SERIES™

875iS SERIES™



795066

x1

4240

795066 x5



692046

x1

4221

692046 x5



796254

x1



399781S

x1



298090S

x1

4105

298090S x5



691894

x1



395051R

x1

7,5m – Ø int. 6,35mm, Ø ext. 11mm

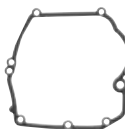

692232

x1

4182

692232 x5



691038

Ø 11mm x1

4230

691038 x100



280399S

x1



791850

Ø 13mm x1

4171

791850 x5

4229

791850 x100



281434S

x1



792020

x1

7,5m – Ø int. 6,35mm, Ø ext. 13mm



790965

x1

62m, Ø 3,2mm



698183

x1



799716

x1



493880S



795990



66538S



992235

ENGINE CARE

800 SERIES™, 850 SERIES™, 850 SERIES™ I/C®,
875 SERIES™



222698S



4181

222698S



4144

222698S



950E SERIES™

MODEL: 14B9



950E
SERIES™



795066

x1

4240

795066 x5



698183

x1



796254

x1



692046

x1

4221

692046 x5



298090S

x1

4105

298090S x5



399781S

x1



395051R

x1

7,5m - Ø int. 6,35mm, Ø ext. 11mm



691894

x1



691038

Ø 11mm x1

4230

691038 x100



692232

x1

4182

692232 x10



791850

Ø 13mm x1

4171

791850 x5

4229

791850 x100



281434S

x1



792020

x1

7,5m - Ø int. 6,35mm, Ø ext. 13mm



790965

x1

62m, Ø 3,2mm



697316

x1



493880S

x1



66538S



795990



4-STROKE OIL

FOR MAXIMUM PERFORMANCE

- Briggs & Stratton's range of 4-stroke oil is specially formulated for small engines and is suitable for all outdoor power equipment.
- Available container sizes from 0.5L right up to 200L.
- All 4-stroke oil graded SAE 30 API SJ.
- New packaging, dedicated video guides and effective Point-Of-Sale solutions available.



INTEK™ INTEK™ PRO

MODEL: 12x6



INTEK™



INTEK™ PRO

	697029	x1		792020	x1
	4207	697029 x4		7,5m – Ø int. 6,35mm, Ø ext. 13mm	
	273356S	x1		791850	Ø 13mm x1
	4201	273356S x5		4171	791850 x5
	398188	x1		4229	791850 x100
	694395	x1		698183	x1
	4180	694395 x5		692046	x1
	298090S	x1		4221	692046 x5
	4105	298090S x5		399781S	x1
	692513	x1		691894	x1
	395051R	x1		692232	x1
				7,5m – Ø int. 6,35mm, Ø ext. 11mm	
	691038	Ø 11mm x1		4182	692232 x10
	4230	691038 x100		693981	x1



280399S



790965

62m, Ø 3,2mm



281434S



799716



281505S



4204

281505S



493880S



498144



66538S



692299



222698S



4181

222698S

4144

































222698S

550 SERIES™

MODEL: 0831



550 SERIES™





































	796970 4238	 x1 796970  x5		794641	 x1
	394358S 4112	 x1 394358S  x5		280399S	 x1
	797346	 x1		691915	 x1
	395051R 7,5m – Ø int. 6,35mm, Ø ext. 11mm	 x1		790965 62m, Ø 3,2mm	 x1
	691038 4230	Ø 11mm  x1 691038  x100		797658	 x1
	792020 7,5m – Ø int. 6,35mm, Ø ext. 13mm	 x1		797325	 x1
	791850 4171 4229	Ø 13mm  x1 791850  x5 791850  x100		797286	 x1

750 SERIES™

MODEL: 1062



750
SERIES™

	590601			691915	
	590602			790965	
				62m, Ø 3,2mm	
	395051R			797658	
	7,5m – Ø int. 6,35mm, Ø ext. 11mm				
	691038	Ø 11mm 		794641	
	4230	691038 			
	792020			797346	
	7,5m – Ø int. 6,35mm, Ø ext. 13mm				
	791850	Ø 13mm 		394358S	
	4171	791850 		4112	394358S 
	4229	791850 			
	280399S			590716	

800 SERIES™ 900 SERIES™











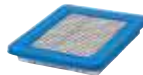























POWERBUILT™ – MODEL: 1263, 1210



800
SERIES™



900
SERIES™

	491588S 4101 491588L	 x1  x5  x50		281434S	 x1
	398188	 x1		281505S 4204	 x1 281505S  x5
	791850 4171 4229	Ø 13mm  x1 791850  x5 791850  x100		498144	 x1
	792020	 x1		692299	 x1
	7,5m – Ø int. 6,35mm, Ø ext. 13mm				
	795027	 x1		790965	 x1
			62m, Ø 3,2mm		
	281370S 4203	 x1 281370S  x5		798619	 x1
	693981	 x1		281658S	 x1

1350 SERIES™ 1450 SERIES™

INTEK™, INTEK™ I/C® – MODEL: 2013, 2043



1350
SERIES™



1450
SERIES™

	491588S			498144	
	4101				
	491588L				
	791850			692299	
	4171				
	4229				
	792020			790965	
	7,5m – Ø int. 6,35mm, Ø ext. 13mm			62m, Ø 3,2mm	
	795027			798619	
	281434S			281658S	
	281505S				
	4204				

INTEK™ PRO

MODEL: 1213, 1214



INTEK™ PRO

	697029 4207	 		281370S 4203	
	273356S 4201	 		693981	
	398188			280399S	
	395051R 7,5m – Ø int. 6,35mm, Ø ext. 11mm			281434S	
	691038 4230	Ø 11mm 		281505S 4204	
	791850 4171 4229	Ø 13mm 		498144	
	792020 7,5m – Ø int. 6,35mm, Ø ext. 13mm			692299	
	795027			790965 62m, Ø 3,2mm	



798619



281658S



ULTRACARE™

992431
Paper Towels



992416
Bio Cleaning Spray 0,5L



992432
2x Paper Towel Rolls



992417
Dirt Protector 0,5L



992420
Heavy Duty
Degreaser 200ml



992418
Hand Cleaner 600ml



992429
Microfibre Cloths

992419
Carburettor Cleaner
200ml

**Briggs and Stratton's UltraCare™ cleaning range is now available.*
For further information please contact your Briggs & Stratton
sales representative.**

*Not offered in the Pre-Season Programme.

SERIES 3

POWERBUILT™ I/C® INTEK™ MODEL: 21x7, 21x8, 21x9



SERIES 3



794421

x1

4213

794421 x6



697292

x1

4212

697292 x6



591583

x1

4242

591583 x5



298090S

x1

4105

298090S x5



691035

x1

4129

691035 x5



491056

x1

4153

491056 x12



492932S

x1

4154

492932S x12



792020

x1

7,5m – Ø int. 6,35mm, Ø ext. 13mm



791850

Ø 13mm x1

4171

791850 x5

4229

791850 x100



698183

x1



281505S

x1

4204

281505S x5



790966

x1

62m, Ø 3.6mm



593934

x1



593935

x1



695708

x1

4194

695708 x5



691909

x1



692424



992242

ENGINE CARE

MODEL 21, SERIES 3 POWERBUILT™,
INTEK™ I/C® OHV 21R5, 21R6, 21R7, 21R8



992236

ENGINE CARE

POWERBUILT™ OHV, INTEK™, I/C® OHV, I/C® OHV
10,5HP – 13,5HP*



* Power levels are stated gross horsepower per SAE J1940 as rated by Briggs & Stratton.

POWERBUILT™ I/C® I/C® QUIET
DIAMOND™ I/C® HIGH PERFORMANCE I/C®
I/C® OHV INTEK™ OHV MODEL: 28xx, 3107, 3117, 3127, 3137



	496894S			792020	
	4139			791850	
		496894S		7,5m – Ø int. 6,35mm, Ø ext. 13mm	
	272403S			4171	
	4142			4229	
		272403S		Ø 13mm	
	298090S			698183	
	4105			281370S	
		298090S		4203	
	691035			281505S	
	4129			4204	
		691035		281505S	
	491056			790966	
	4153			497595	
		491056		693713	
	492932S				
	4154				
		492932S		62m, Ø 3.6mm	
	395051R				
	691038				
	4230				
		Ø 11mm			
		691038			



695708



4194

695708



691909



493880S



692424



66538S



* Power levels are stated gross horsepower per SAE J1940 as rated by Briggs & Stratton.

SERIES 4
I/C® INTEK™ MODEL: 31x5, 31x6, 31x7



SERIES 4

	794422	x1		395051R	x1
	4214	794422 x6		7,5m – Ø int. 6,35mm, Ø ext. 11mm	
	795115	x1		691038	Ø 11mm x1
	4211	795115 x6		4230	691038 x100
	697015	x1		792020	x1
	4215	697015 x5		7,5m – Ø int. 6,35mm, Ø ext. 13mm	
	594201	x1		791850	Ø 13mm x1
	4243	594201 x5		4171	791850 x5
	298090S	x1		4229	791850 x100
	4105	298090S x5		698183	x1
	691035	x1		281505S	x1
	4129	691035 x5		4204	281505S x5
	491056	x1		790966	x1
	4153	491056 x12		62m, Ø 3.6mm	
	492932S	x1		593934	x1
	4154	492932S x12			



693713



691909



695708



692424



4194

695708



66538S



992238

ENGINE CARE
MODEL 28, MODEL 31 I/C® OHV
14.5HP – 18.5HP* VERTICAL



493880S



992243

ENGINE CARE
MODEL 31, SERIES 4 INTEK™ I/C® OHV
31R7, 31R8, 31R9



* Power levels are stated gross horsepower per SAE J1940 as rated by Briggs & Stratton.

SERIES 7 INTEK™ PROFESSIONAL SERIES™ MODEL: 40x5, 40x6, 40x7
SERIES 8 INTEK™ PROFESSIONAL SERIES™ MODEL: 44x5, 44x6, 44x7
SERIES 8 COMMERCIAL TURF SERIES™ MODEL: 44T8



SERIES 7

SERIES 8

	499486S			691035	
	4223			4129	
	792101			491056	
	273638S			4153	
	792105			492932S	
	4233			4154	
	792303			395051R	
	798897			691038	
	594201			4230	
	4243			792020	
	298090S			791850	
	4105			4171	
				4229	
				698183	



695708



4194

695708



493880S



693713



66538S

































VANGUARD™ 5,5 - 6,5 GROSS HP*

MODEL: 13H1, 13L1, 13H3, 13L3



VANGUARD™

	797033 4239	 x1 797033  x5		794641	 x1
	798513	 x1		798635	 x1
	792917	 x1		490652 4130	 x1 490652  x5
	395051R	 x1		790966	 x1
	7,5m – Ø int. 6,35mm, Ø ext. 11mm			62m, Ø 3.6mm	
	691038 4230	Ø 11mm  x1 691038  x100		493880S	 x1
	792020	 x1		798619	 x1
	7,5m – Ø int. 6,35mm, Ø ext. 13mm				
	791850 4171 4229	Ø 13mm  x1 791850  x5 791850  x100			

* Power levels are stated gross horsepower per SAE J1940 as rated by Briggs & Stratton.

VANGUARD™ 8 - 10 GROSS HP*

MODEL: 19H1, 19L1, 19H2, 19L2



VANGUARD™



797032



794641



798795



798635



792917



490652



4130

490652



395051R



7,5m - Ø int. 6,35mm, Ø ext. 11mm



790966



62m, Ø 3.6mm



691038

Ø 11mm



493880S



4230

691038



792020



7,5m - Ø int. 6,35mm, Ø ext. 13mm



691909



791850

Ø 13mm



798503



4171

791850



4229

791850













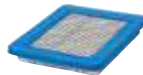















* Power levels are stated gross horsepower per SAE J1940 as rated by Briggs & Stratton.

VANGUARD™ 7,5 - 9 GROSS HP*

MODEL: 1384, 1854



VANGUARD™

	491588S 4101 491588L	  		490652 4130	 
	491435S 4146	 		710634	
	710065			790966 62m, Ø 3.6mm	
	710075 4228	Ø 10.50mm  		715588	
	710490			715589	
	716111				

* Power levels are stated gross horsepower per SAE J1940 as rated by Briggs & Stratton.

VANGUARD™ 14 - 16 - 18 GROSS HP*

MODEL: 29x4, 29x7, 30x4, 30x7, 35x4



VANGUARD™



394018S



4135

394018S



698183



272490S



4111

272490S



792020



7,5m - Ø int. 6,35mm, Ø ext. 13mm



691035



4129

691035



791850

Ø 13mm

4171

791850

4229

791850



491056



4153

491056



281370S



4203

281370S



492932S



4154

492932S



790967



62m, Ø 4,4mm



842921



4237

842921



695708



4194

695708



395051R



7,5m - Ø int. 6,35mm, Ø ext. 11mm



493880S



691038

Ø 11mm

4230

691038



692076



















* Power levels are stated gross horsepower per SAE J1940 as rated by Briggs & Stratton.

VANGUARD™ 18 - 20 - 22 - 23

GROSS HP* MODEL: 35x7, 38x4, 3867



VANGUARD™

	692519 4232	x1 x5		692076	x1
	692520 4257	x1 x5		792020	x1
	691035 4129	x1 x5		791850 4171 4229	Ø 13mm x1 791850 x5 791850 x100
	491056 4153	x1 x12		698183	x1
	492932S 4154	x1 x12		281370S 4203	x1 281370S x5
	842921 4237	x1 x12		790967	x1
	395051R	x1		695708 4194	x1 695708 x5
	691038 4230	Ø 11mm x1 x100		493880S	x1

* Power levels are stated gross horsepower per SAE J1940 as rated by Briggs & Stratton.

DEMAND GENUINE PARTS

Only Briggs & Stratton® Genuine Parts are specifically designed, manufactured and tested to help deliver optimum performance in Briggs & Stratton® engines.

Exact fit and performance

Trusted brand

Meet emissions regulations*

One year warranty

Full technical support

DEMAND QUALITY



*Installing genuine Briggs & Stratton® parts ensures that Briggs & Stratton® engines comply with applicable (EPA) emission regulations.



09P6020014H1YY0001

500E SERIES™

Ø **22.2mm - 7/8"**

62mm

Primer – Flywheel Break – Light Flywheel – Lo-Tone Muffler



09P6020015H1YY0001

500E SERIES™

Ø **22.2mm - 7/8"**

80mm

Primer – Flywheel Break – Light Flywheel – Lo-Tone Muffler



126T020074H1YY0001

675EX SERIES™

Ø **22.2mm - 7/8"**

80mm

Readystart™ – Band Break – Light Flywheel – Performance Muffler



126T020075H1YY0001

675EX SERIES™

Ø **22.2mm - 7/8"**

62mm

Readystart™ – Band Break – Light Flywheel – Performance Muffler



0831321112H1BF7001

550 SERIES™

Ø **19.05mm - 3/4"**

61.5mm

Manual Choke – Heavy Flywheel – Lo-Tone Muffler

* Power levels are stated gross horsepower per SAE J1940 as rated by Briggs & Stratton.



1062320129H1YY7001

750 SERIES™

 Ø **19.05mm - 3/4"**

 **61.5mm**

Manual Choke – Heavy Flywheel – Lo-Tone Muffler



1263023236H8R7001

800 SERIES™

 Ø **19.05mm - 3/4"**

 **62mm**

Manual Choke – Heavy Flywheel – Lo-Tone Muffler



21R8070062B1CC0001

POWERBUILT™ SERIES 3130

 Ø **25.4mm - 1"**

 **80mm**

13,5 HP* – Choke-a-matic – Light Flywheel – Electric Start – Alt 9A – Fuel Pump



31R5070011B1CC0001

INTEK™ SERIES 4155

 Ø **25.4mm - 1"**

 **80mm**

15,5 HP* – Choke-a-Matic – Light Flywheel – Electric Start – Alt 9A – AVS®



31R7770010B1CC0001

INTEK™ SERIES 4175

 Ø **25.4mm - 1"**

 **80mm**

17,5 HP* – Choke-a-matic – Light Flywheel – Electric Start – Alt 9A – Performance Quiet Muffler – Fuel Pump – Oil Filter – AVS®

NEW BRIGGS & STRATTON POINT OF SALE DISPLAY STAND*

For further information please contact your
Briggs & Stratton sales representative.



992435

240cm Free Standing Display Unit
with Shelving and Eurohooks.

Provided without products.**

Display is also available in 140cm
and as 140cm gondola.



*Display stand not offered in the Pre-Season Programme

**For shown consumer parts please refer to the Consumer Parts Guide

ALLOW 1.80 CLEARANCE
FOR LATCH OPERATION

OPTIONAL OIL DRAIN HOSE
OPTION #2 LOCATION

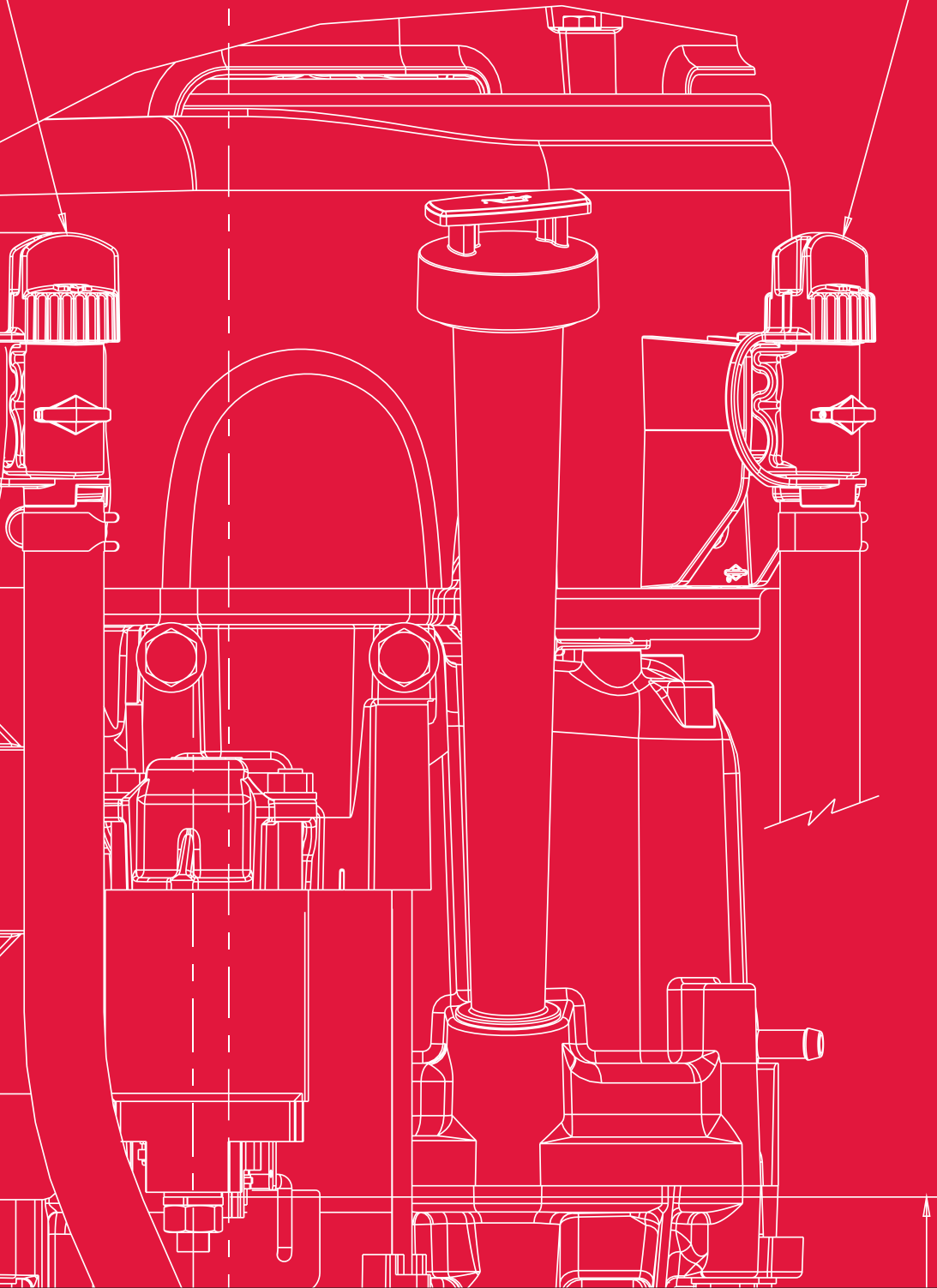

BRIGGS & STRATTON AG

WOLLERAUSTRASSE 41, 8807 FREIENBACH, SWITZERLAND
TEL: +41 (0)55 415 1200 FAX: +41 (0)55 415 1201

WWW.BRIGGSandSTRATTON.COM

©2015 Briggs & Stratton AG